

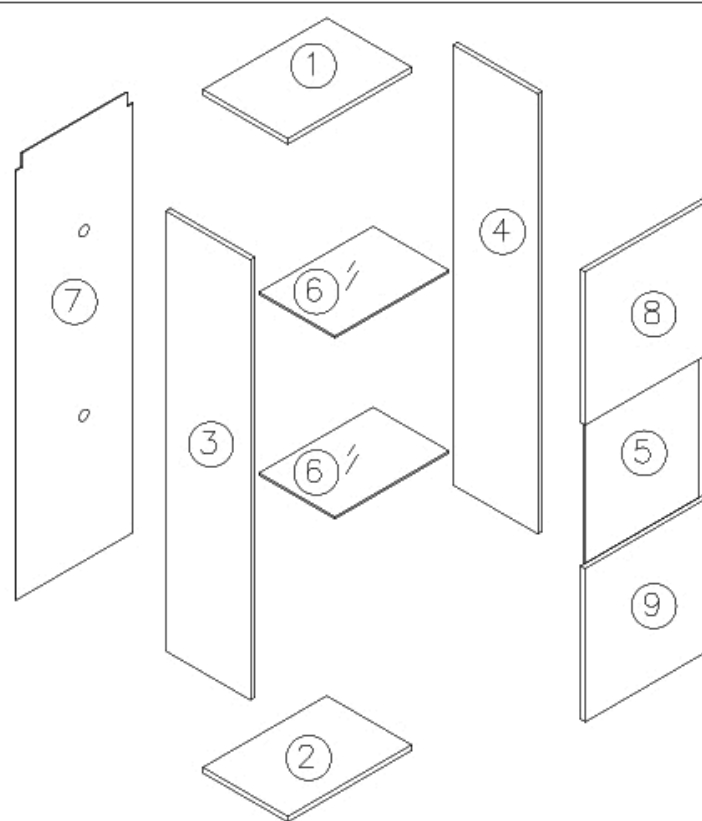

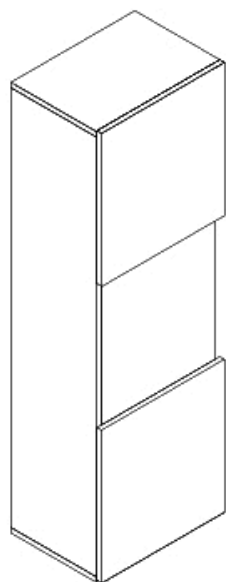

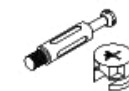





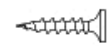
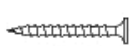

VISD003

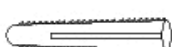
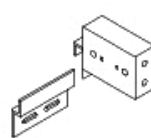

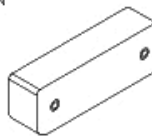
<p>A</p>  <p>8 PCS</p>	<p>B</p>  <p>8PCS</p>	<p>C</p>  <p>4PCS</p>	<p>D</p>  <p>8 PCS</p>	<p>E</p> <p>3*12</p>  <p>12PCS</p>	<p>F</p> <p>3.5*14</p>  <p>32 PCS</p>	<p>G</p> <p>3.5*25</p>  <p>8PCS</p>	<p>H</p> <p>3.5*30</p>  <p>4PCS</p>
<p>I</p> <p>4*50</p>  <p>4PCS</p>	<p>J</p>  <p>4PCS</p>	<p>K</p>  <p>2PCS</p>	<p>L</p>  <p>10PCS</p>	<p>M</p>  <p>10PCS</p>	<p>N</p>  <p>4PCS</p>	<p>O</p>  <p>1PCS</p>	<p>P</p>  <p>6PCS</p>
<p>LED</p>  <p>1PCS</p>							

**1****A\*4 B\*4****2****A\*4 B\*4****3****E\*6 L\*6**

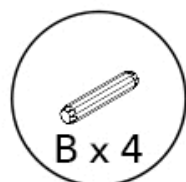
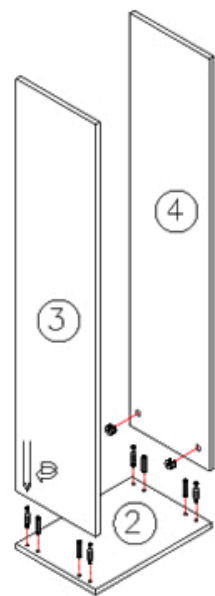
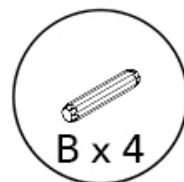
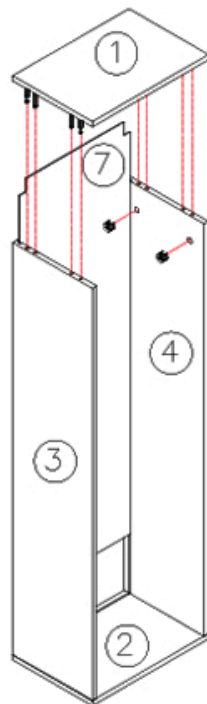
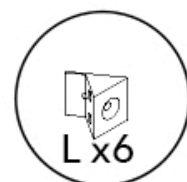
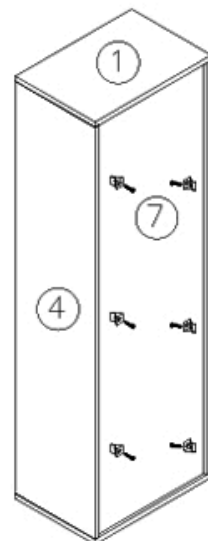
4

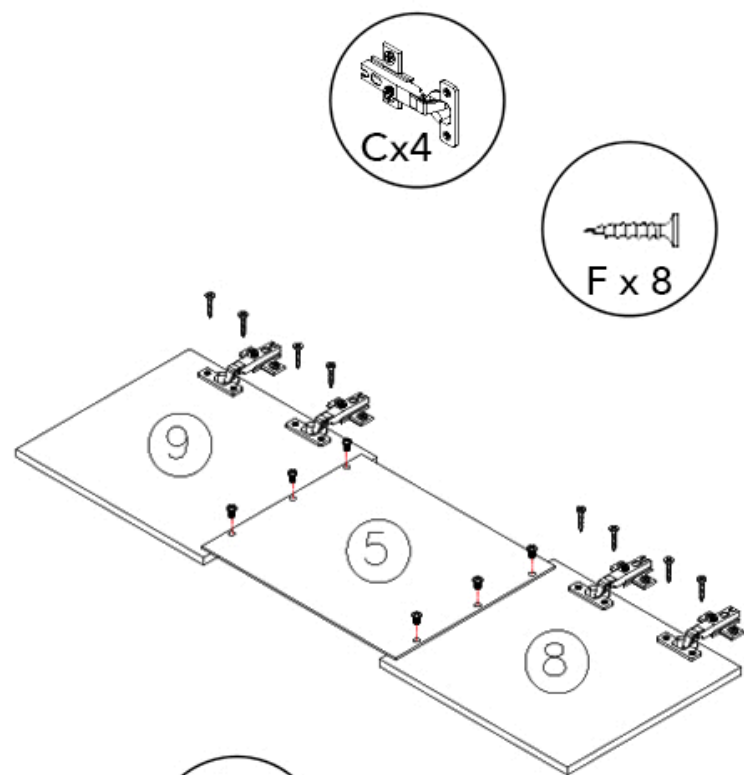

C\*4 F\*8 P\*6

5

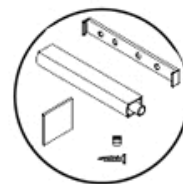
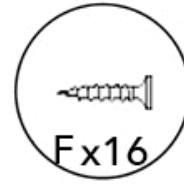
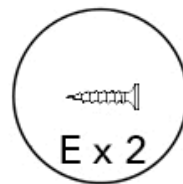
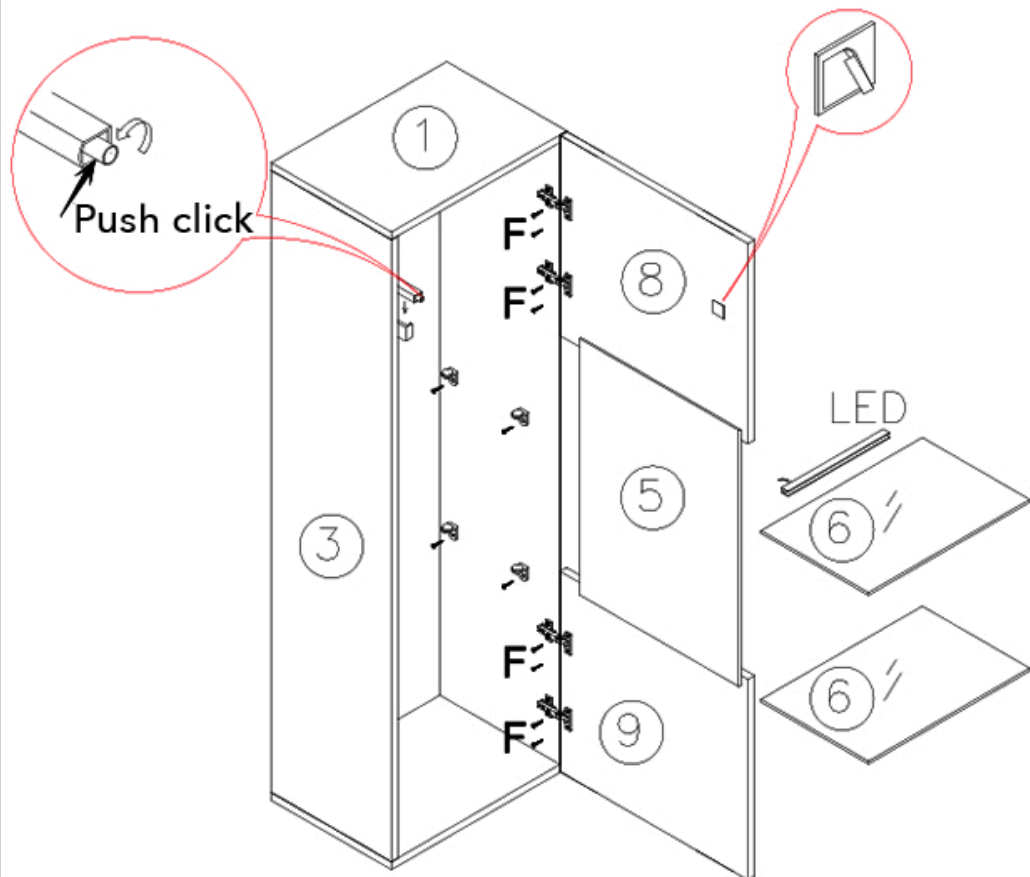

O x 1

D\*8 E\*2 F\*20 O\*1

