

Varedo

Typ:L

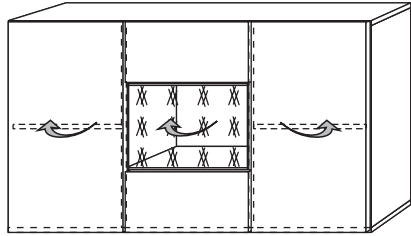

Typ:P

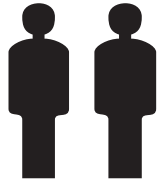
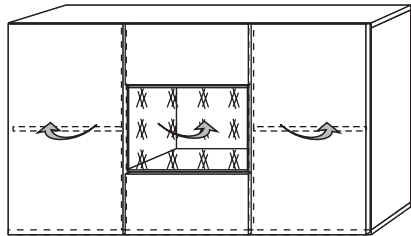

2 Personen
2 Osoby

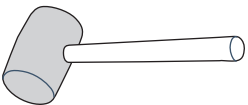
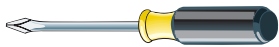
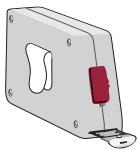

Stärke/Gr.	Spanplatte/Plyta		
Länge/Di. mm	15	18	22
0<400			
401<600	40	40	40
601<800	24		
801<1000	15	30	

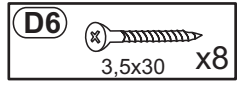
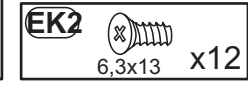
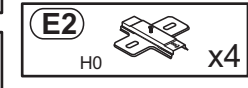
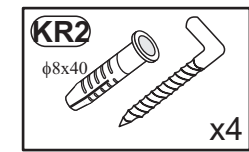
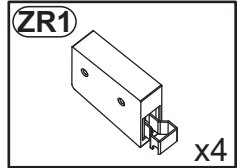
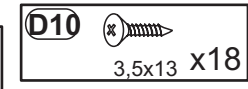
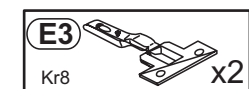
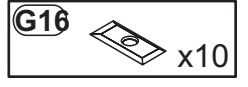
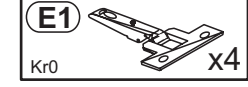
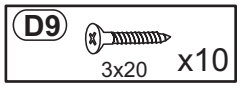
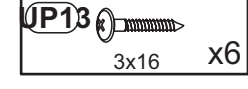
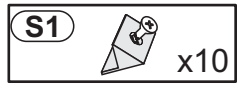
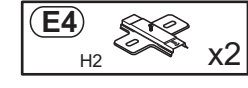
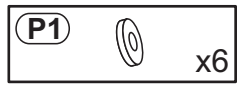
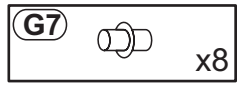
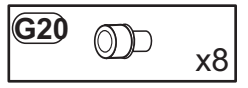
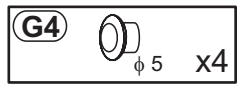
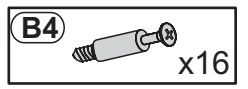
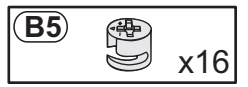
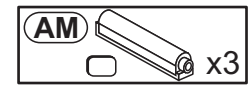
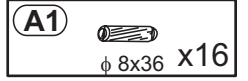
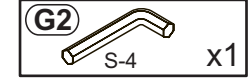
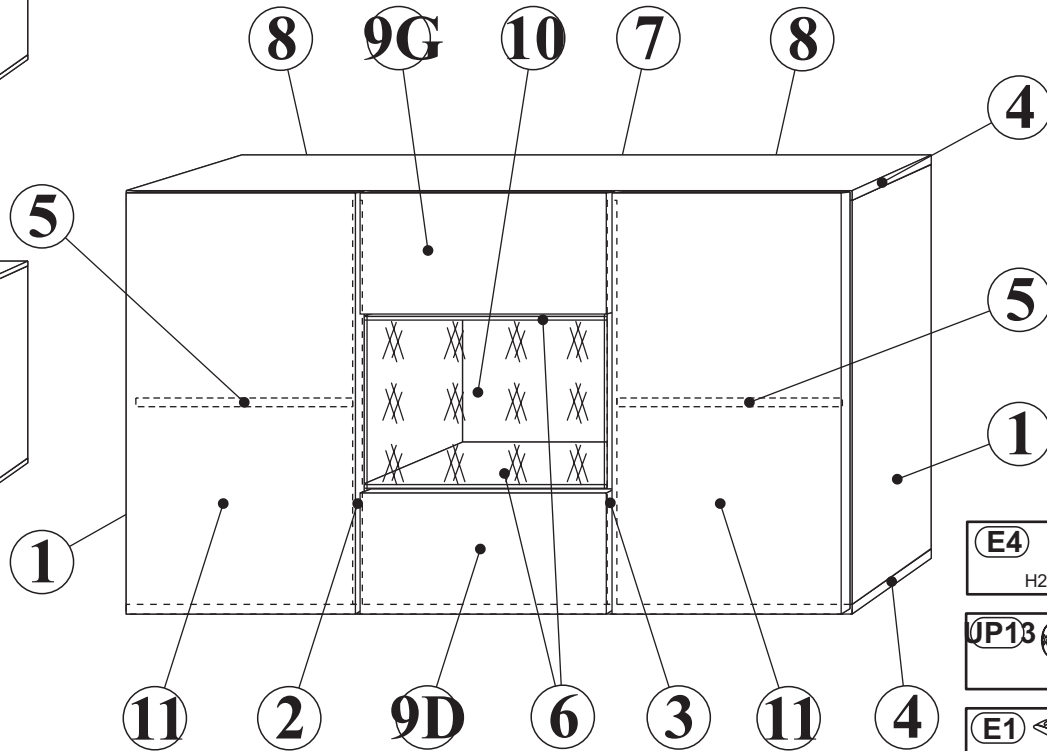

1

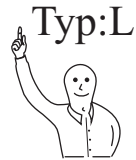
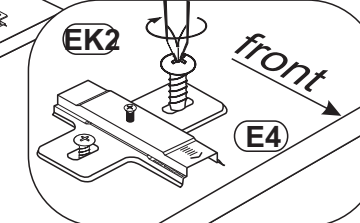
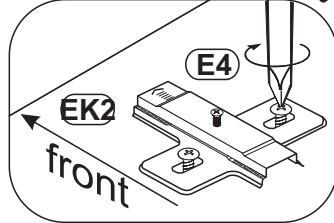
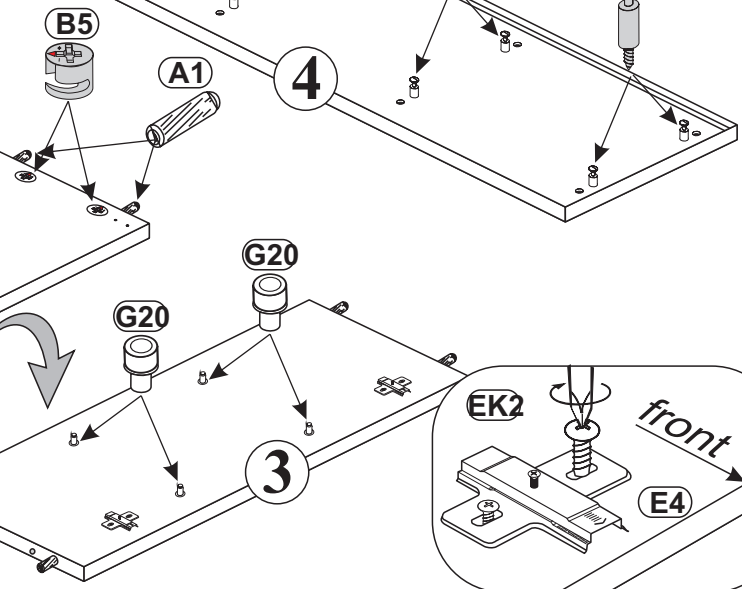
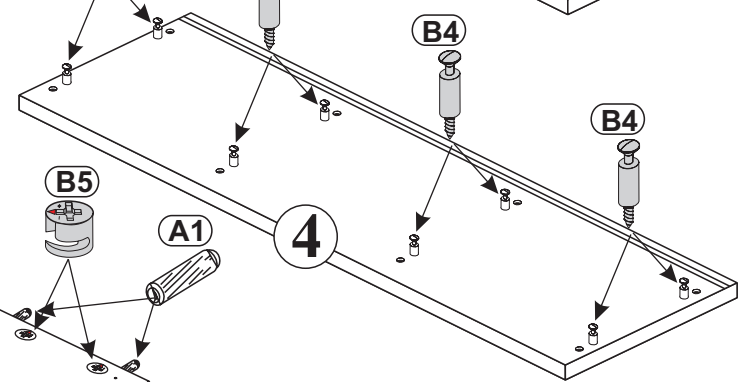
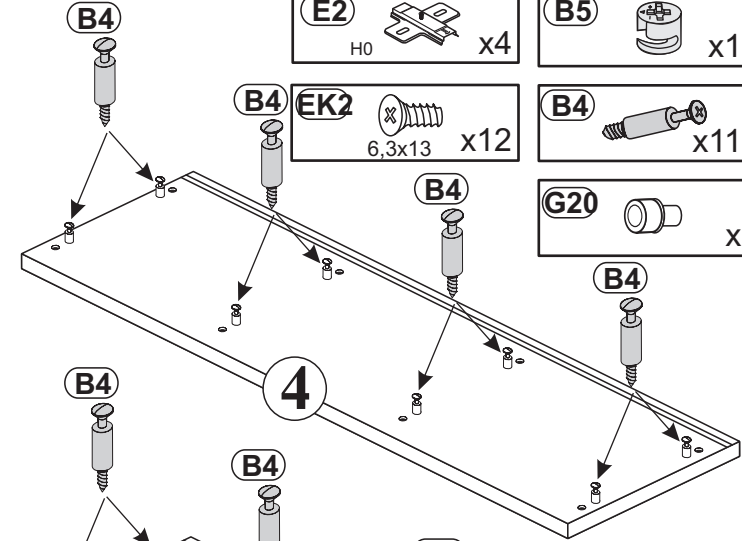
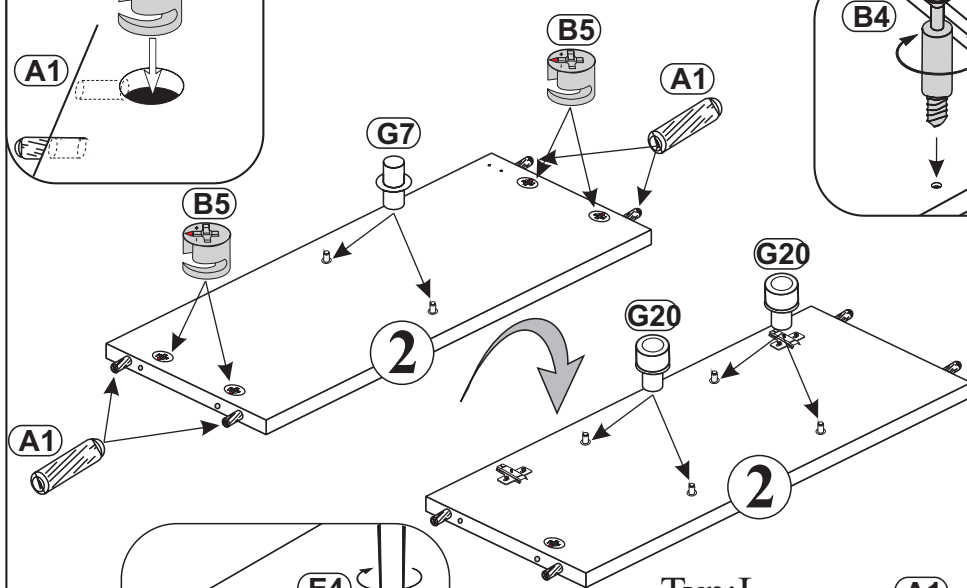
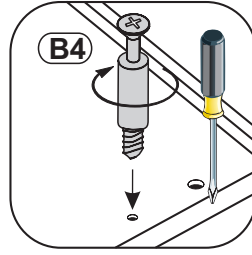
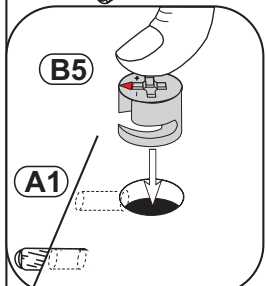
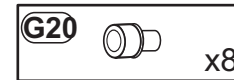
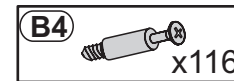
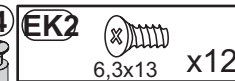
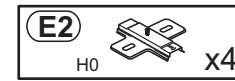
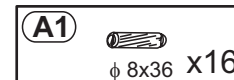
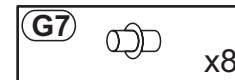
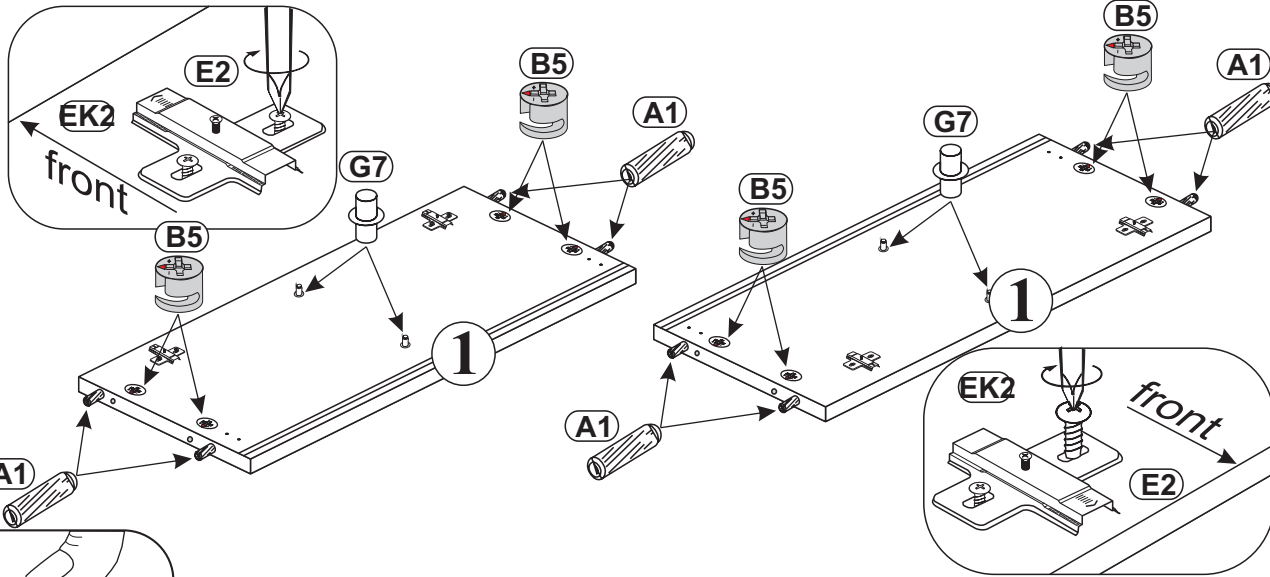

2

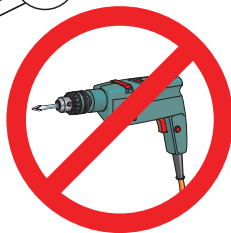
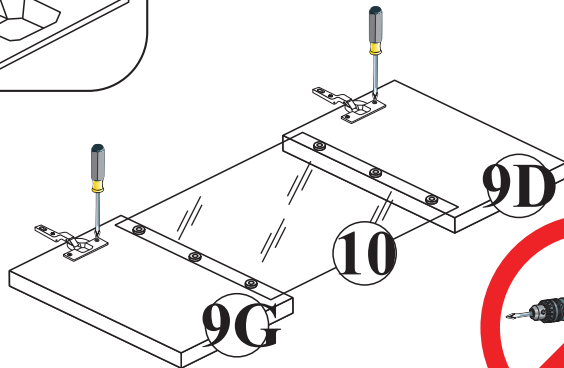
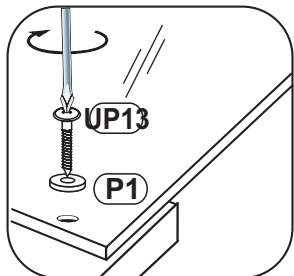
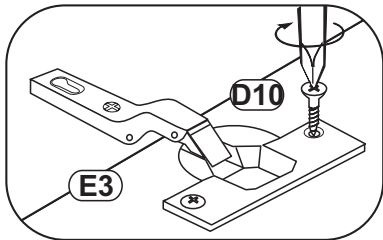
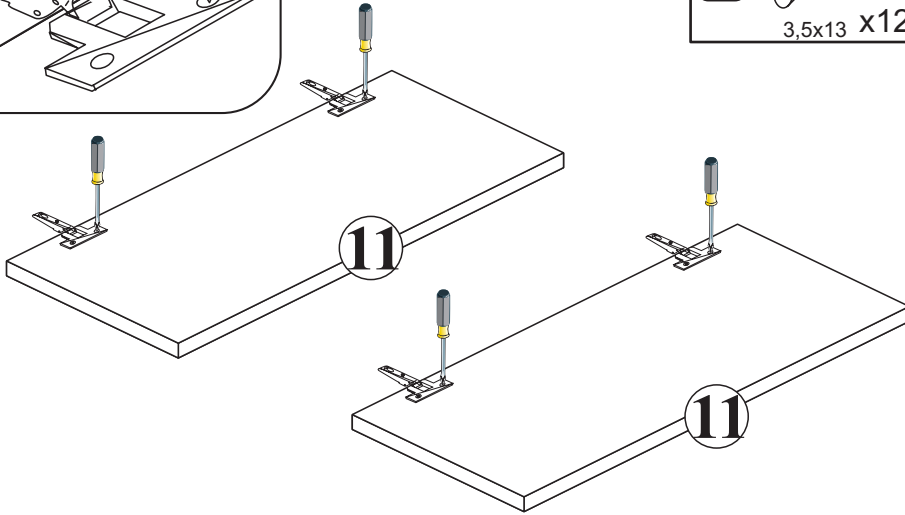
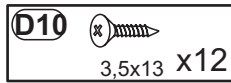
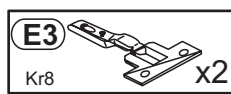
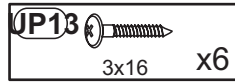
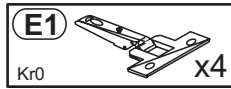
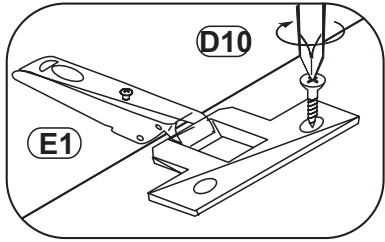

3

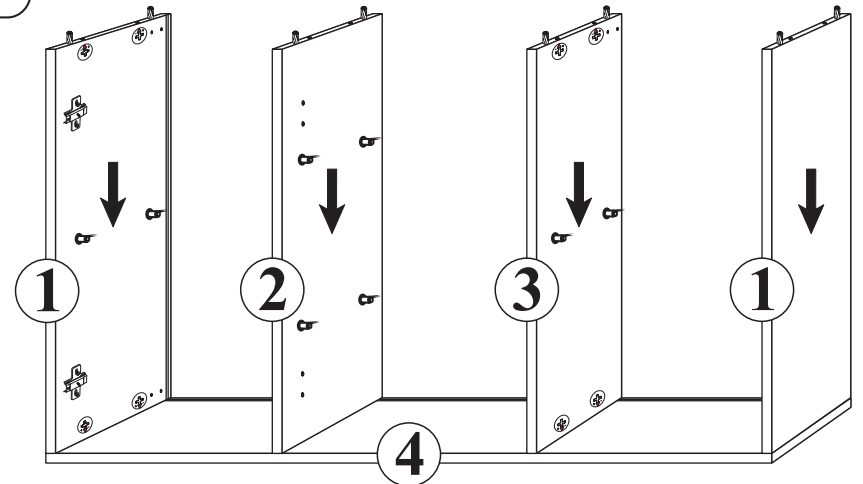
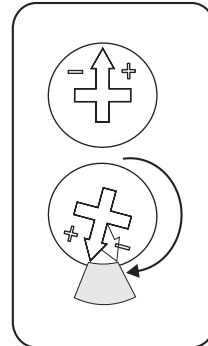
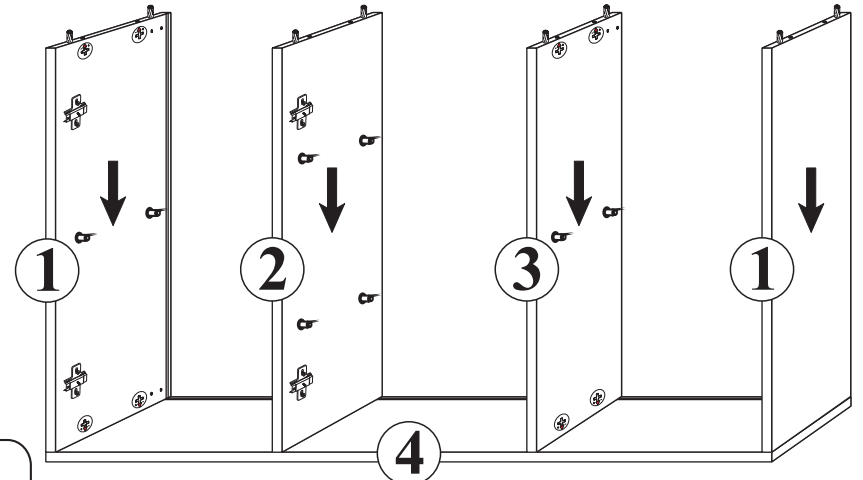
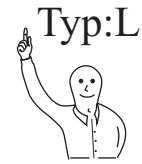

4

Typ:L

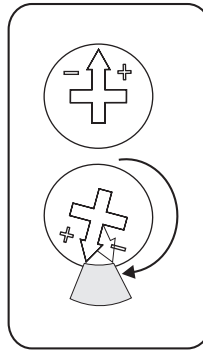
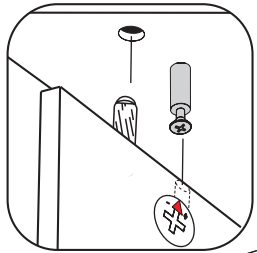
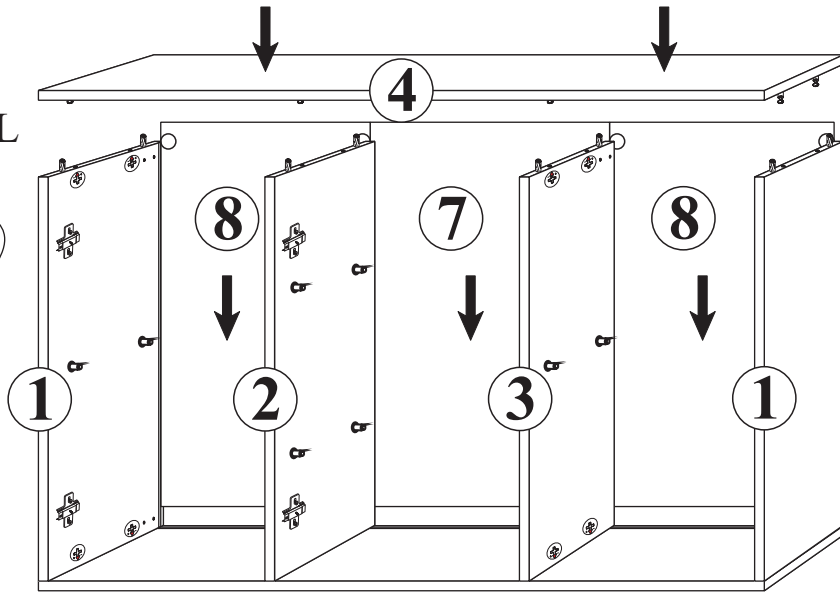

Typ:P

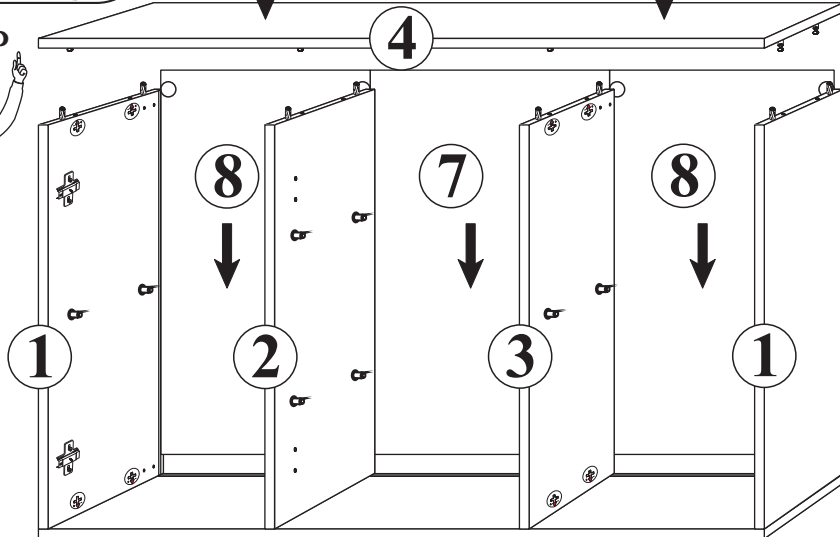

5

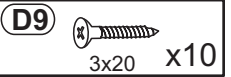

a=b

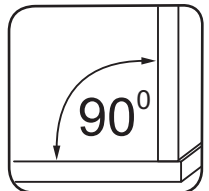
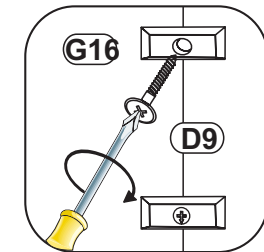
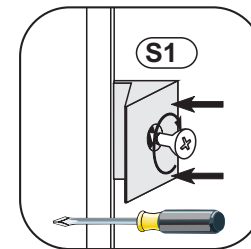
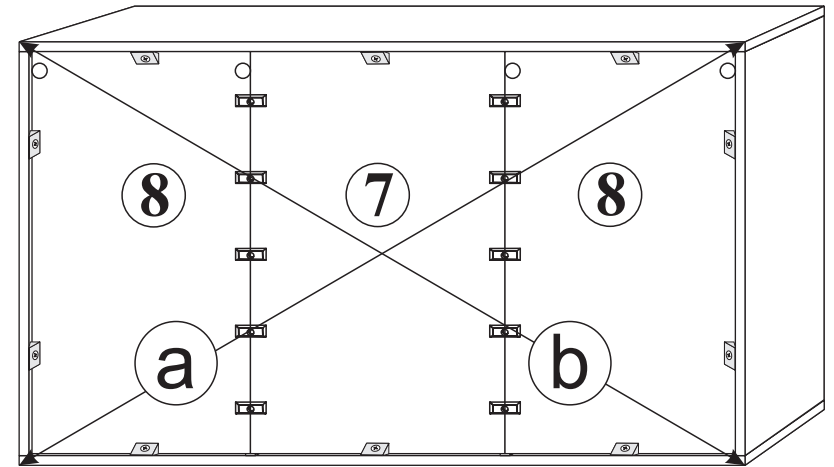

6

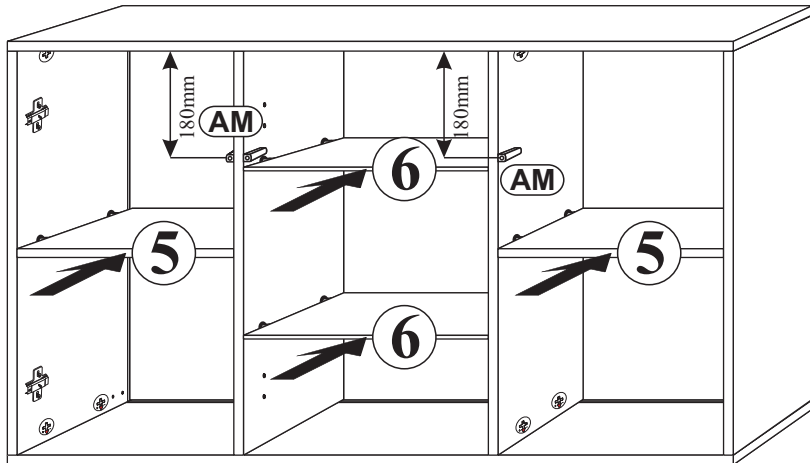
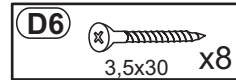
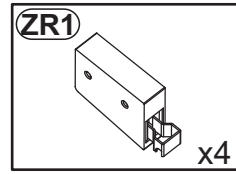
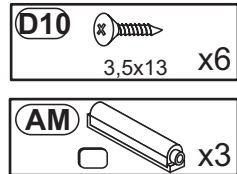
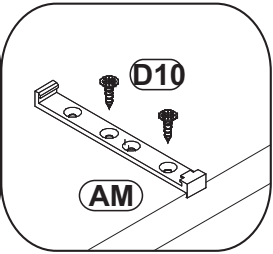
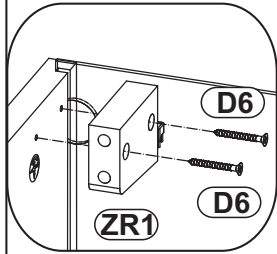
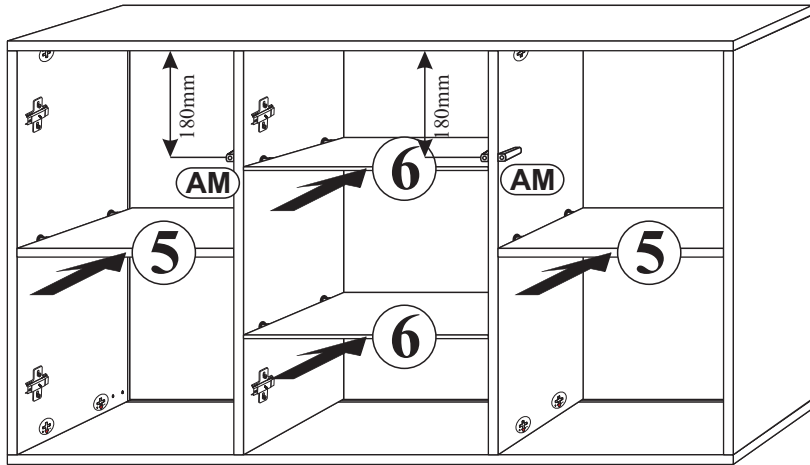

7

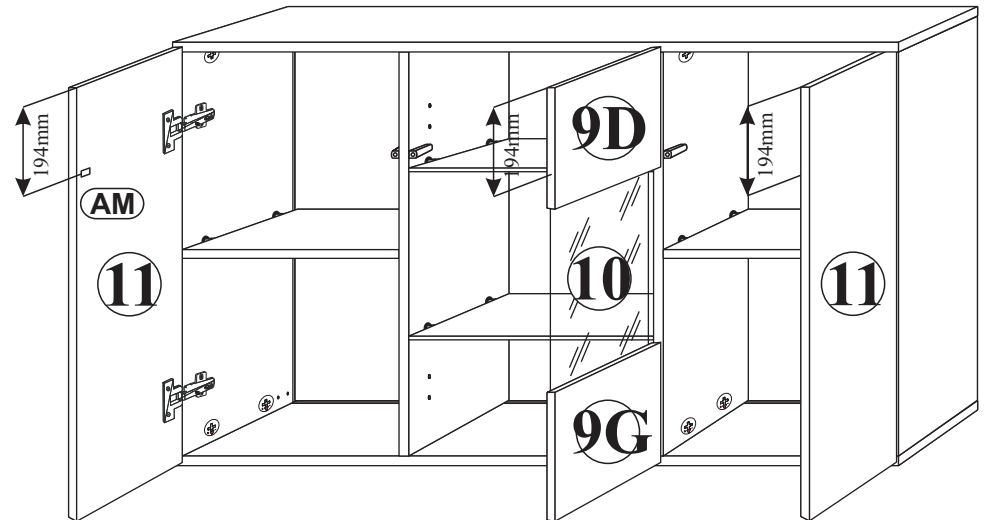
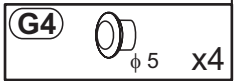
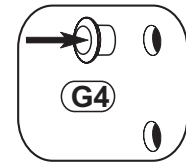
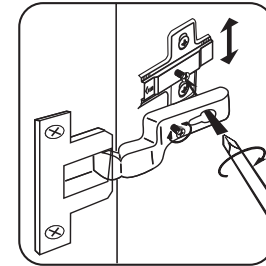
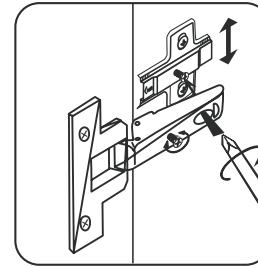
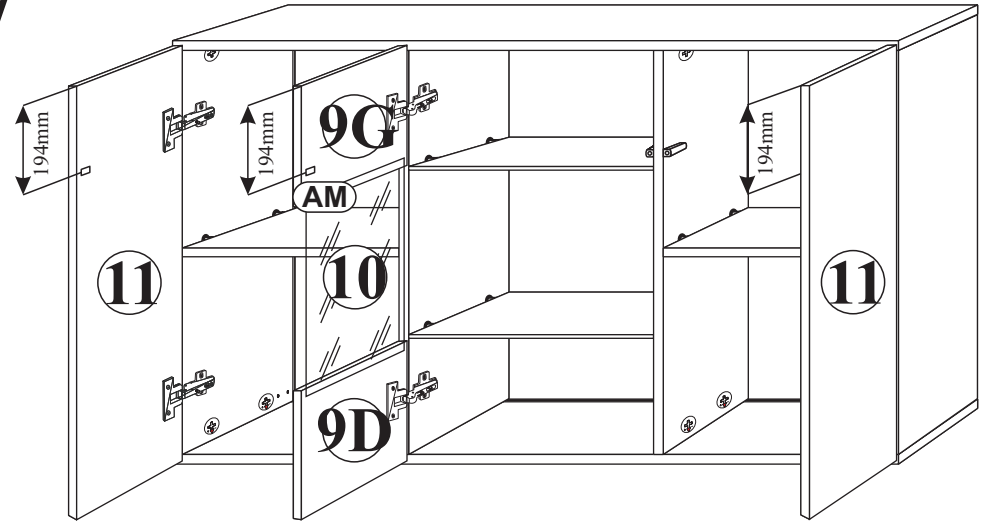

8

G5 #15 x16

KR2 $\phi 8 \times 40$ x4

