

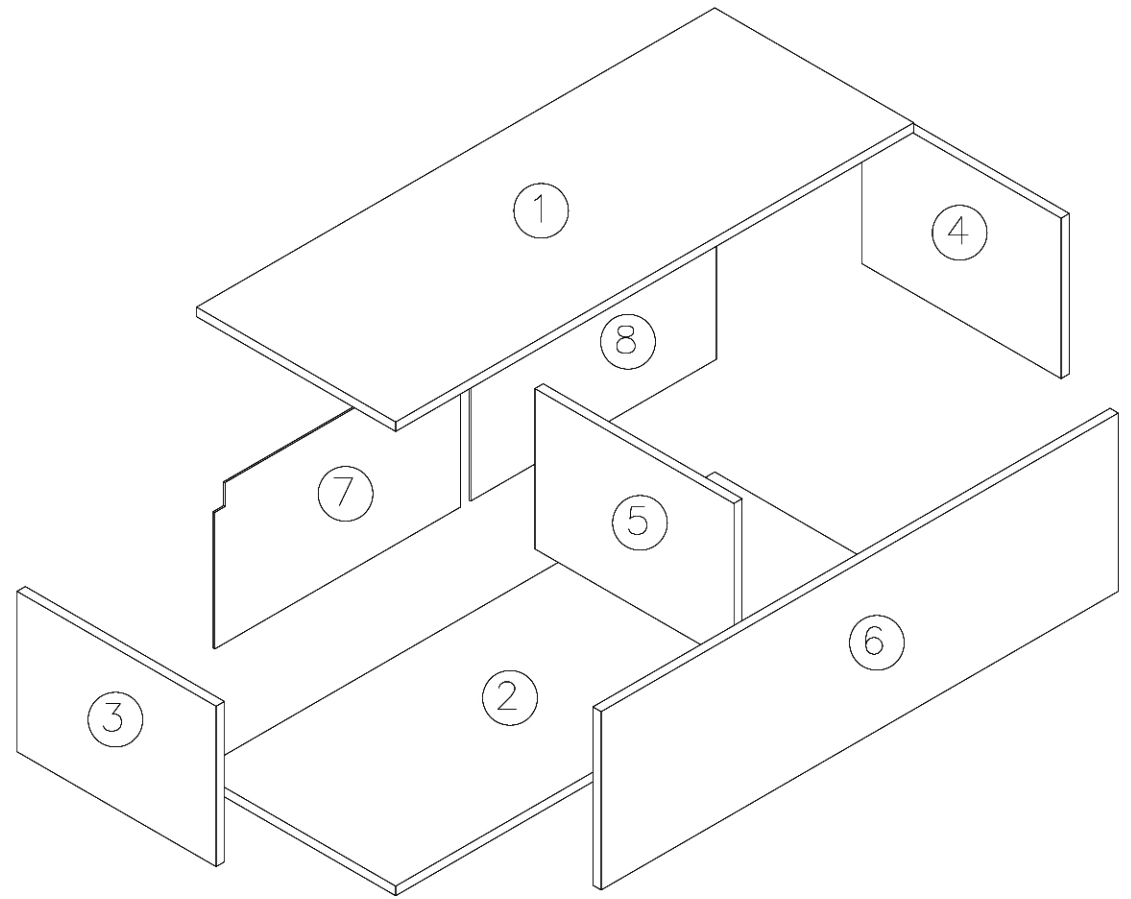

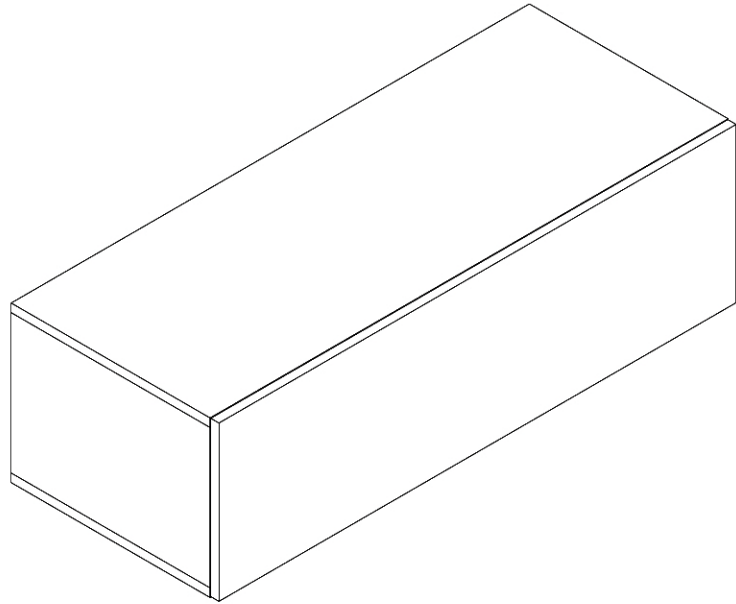

Luke H1

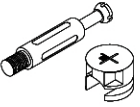
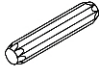
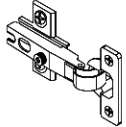
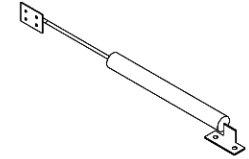
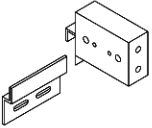

<p>A</p>  <p>12PCS</p>	<p>B</p>  <p>12PCS</p>	<p>C</p>  <p>2PCS</p>	<p>D</p>  <p>1PCS</p>	<p>E</p>  <p>2PCS</p>	<p>F</p> <p>3.5*14</p>  <p>18PCS</p>	<p>G</p> <p>3.5*30</p>  <p>4PCS</p>	<p>H</p> <p>4*50</p>  <p>4PCS</p>
<p>I</p>  <p>4PCS</p>	<p>J</p>  <p>4PCS</p>	<p>K</p> <p>3.5*25</p>  <p>8PCS</p>					

1

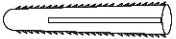
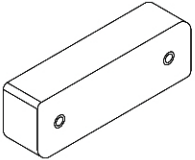
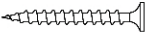
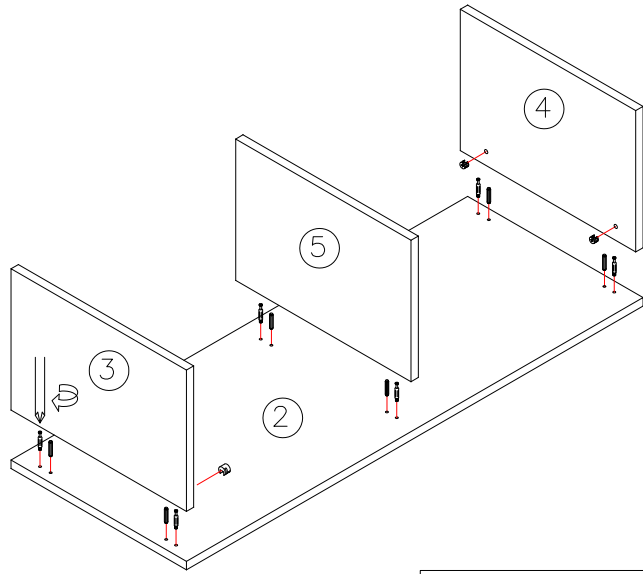

A*6 B*6

2

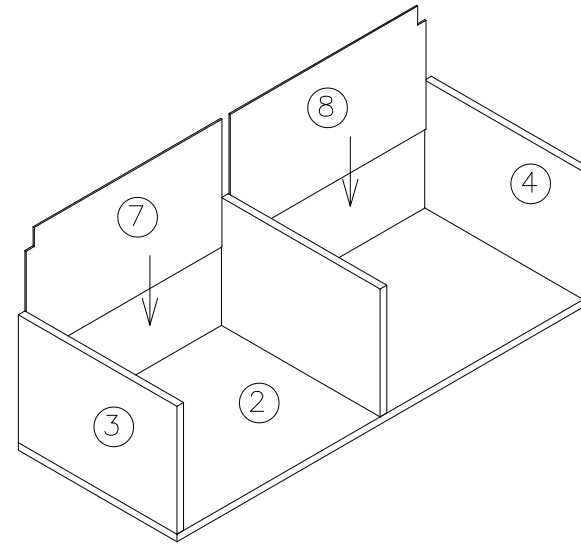

3

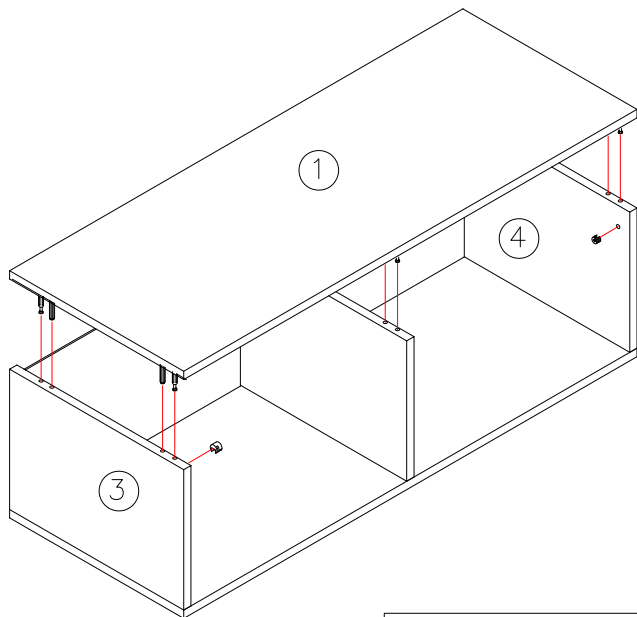

A*6 B*6

4

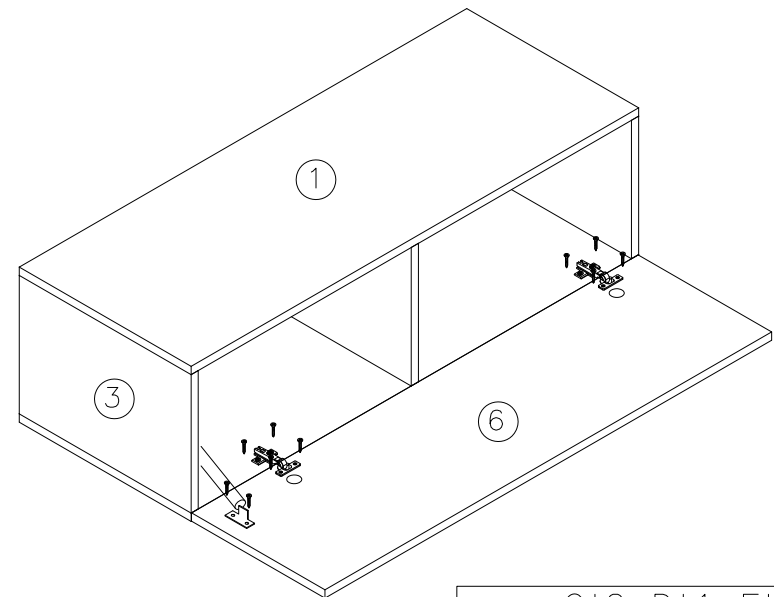

C*2 D*1 F*12

